

BLUE STAR

Power Systems Inc.

Gaseous Product Line

208-600 Volt

NG265-01 / NG265-01P

60 Hz / 1800 RPM

265 kWe / 230 kWe

Standby / Prime

Ratings

	240V	208V	240V	480V	600V
Phase	1	3	3	3	3
PF	1.0	0.8	0.8	0.8	0.8
Hz	60	60	60	60	60
Generator Model	572RSL4027	432CSL6210	432CSL6210	432CSL6210	432PSL6246
Connection	12 LEAD ZIG-ZAG	12 LEAD WYE	12 LEAD DELTA	12 LEAD WYE	4 LEAD WYE
Standby					
kWe Nat (LP)	265 (155)	265 (155)	265 (155)	265 (155)	265 (155)
AMPS Nat (LP)	1104 (646)	921 (538)	798 (467)	399 (233)	319 (187)
Temp Rise	130°C / 27°C	130°C / 27°C	130°C / 27°C	130°C / 27°C	130°C / 27°C
Prime					
kWe Nat (LP)	230 (NA)	230 (NA)	230 (NA)	230 (NA)	230 (NA)
AMPS Nat (LP)	958 (NA)	799 (NA)	692 (NA)	346 (NA)	277 (NA)
Temp Rise	105°C / 40°C	105°C / 40°C	105°C / 40°C	105°C / 40°C	105°C / 40°C

Standard Equipment

Engine

- ▶ Radiator Cooled Unit Mounted (50°C)
- ▶ Blower Fan & Fan Drive
- ▶ Starter & Alternator
- ▶ Oil Pump & Filter
- ▶ Oil Drain Extension w/Valve
- ▶ Governor - Electronic Isochronous
- ▶ 24V Battery System & Cables
- ▶ Air Cleaner (Dry Single Stage)
- ▶ Flexible Fuel Connector
- ▶ EPA Certified
- ▶ MasterTrak Remote Monitoring System

Listing Certifications

- ▶ UL 2200 Listed
- ▶ cUL Listed
- ▶ CSA Certified
- ▶ Seismic Certified to IBC 2012

Generator

- ▶ Brushless Single Bearing
- ▶ Automatic Voltage Regulator
- ▶ ± 1% Voltage Regulation
- ▶ 4 Pole, Rotating Field
- ▶ 130°C Standby Temperature Rise
- ▶ 105°C Prime Temperature Rise
- ▶ 100% of Rated Load - One Step
- ▶ 5% Maximum Harmonic Content
- ▶ NEMA MG 1, IEEE and ANSI Standards Compliance for Temperature Rise

Additional

- ▶ Microprocessor Based Digital Control
- ▶ Interface Connection Box
- ▶ Control Panel Mounted in NEMA 12 Enclosure
- ▶ Base - Structural Steel
- ▶ Main Line Circuit Breaker Mounted & Wired
- ▶ Catalyst / Silencer Mounted
- ▶ Battery Charger 24V 5 Amp
- ▶ Jacket Water Heater -20°F 4000W 240V w/Isolation Valves
- ▶ Vibration Isolation Mounts (Pad Type)
- ▶ Radiator Duct Flange (OPU Only)
- ▶ Single Source Supplier
- ▶ 2YR / 2000HR Standby Warranty
- ▶ 1YR / 1500HR Prime Warranty
- ▶ Standard Colors - White / Tan / Gray

Application Data

Engine			
Manufacturer:	Power Solutions International	Displacement - Cu. In. (lit):	892 (14.6)
Model:	D146TIC	Bore - in. (cm) x Stroke - in. (cm):	5.04 (12.8) x 5.59 (14.2)
Type:	4-Cycle	Compression Ratio:	10.5 : 1
Aspiration:	Turbo Charged, CAC	Rated RPM:	1800
Cylinder Arrangement:	8 Cylinder Vee	Max HP Stby (kWm):	402 (300)

Exhaust System	Standby	Prime
Gas Temp. (Stack): °F (°C)	1,350 (732)	1,350 (732)
Gas Volume at Stack Temp: CFM (m³/min)	1,895 (53.6)	1,645 (46.5)
Maximum Allowable Exhaust Restriction: in. H ₂ O (kPa)	40.8 (10.2)	40.8 (10.2)

Cooling System		
Ambient Capacity of Radiator: °F (°C)	122 (50.0)	122 (50.0)
Maximum Allowable Static Pressure on Rad. Exhaust: in. H ₂ O (kPa)	0.50 (0.12)	0.50 (0.12)
Water Pump Flow Rate: GPM (lit/min)	180 (681)	180 (681)
Heat Rejection to Coolant: BTUM (kW)	16,189 (285)	14,051 (246)
Heat Rejection to CAC: BTUM (kW)	4,682 (81.9)	4,064 (71.1)
Heat Radiated to Ambient: BTUM (kW)	3,017 (52.8)	2,619 (45.8)

Air Requirements		
Aspirating: CFM (m³/min)	603 (17.1)	523 (14.8)
Air Flow Required for Rad. Cooled Unit: CFM (m³/min)	30,000 (849)	30,000 (849)
Air Flow Required for Heat Exchanger/Rem. Rad. CFM (m³/min)	Consult Factory For Remote Cooled Applications	

Fuel Consumption	Standby		Prime	
	Natural Gas	LP	Natural Gas	LP
At 100% of Power Rating: ft ³ /hr (m ³ /hr)	2,782 (78.7)	1,113 (31.5)	2,415 (68.3)	966 (27.3)
At 75% of Power Rating: ft ³ /hr (m ³ /hr)	2,168 (61.4)	867 (34.7)	1,882 (53.3)	753 (21.3)
At 50% of Power Rating: ft ³ /hr (m ³ /hr)	1,522 (43.1)	609 (17.2)	1,321 (37.4)	528 (15.0)
Fuel Inlet Size: NPT	3.00"		3.00"	
Fuel Pressure Required: in. H ₂ O (kPa)	7.00 - 11.0 (1.75 - 2.75)		7.00 - 11.0 (1.75 - 2.75)	

Fluids Capacity	
Total Oil System: gal (lit)	8.19 (31.0)
Engine Jacket Water Capacity: gal (lit)	11.4 (43.2)
System Coolant Capacity: gal (lit)	33.5 (127)

All calculations based on natural gas fuel.

Deration Factors: Temperature: Derate 1.5% Per 10°F Over 77°F Air Inlet Temperature | Altitude: Derate 2.5% Per 1000ft Over 1200ft

DGC-2020 Control Panel

Standard Features

- ▶ Digital Metering
- ▶ Engine Parameters
- ▶ Generator Protection Functions
- ▶ Engine Protection
- ▶ CAN Bus ECU Communications
- ▶ Windows-Based Software
- ▶ Multilingual Capability
- ▶ Remote Communications to RDP-110 Remote Annunciator
- ▶ 16 Programmable Contact Inputs
- ▶ Up to 15 Contact Outputs (7 standard)
- ▶ UL Recognized, CSA Certified, CE Approved
- ▶ Event Recording
- ▶ IP 54 Front Panel Rating with Integrated Gasket
- ▶ NFPA 110 Level 1 Compatible



Weights / Dimensions / Sound Data

	L x W x H	Weight lbs
OPU	140 x 78 x 90 in	8,725
Level 1	140 x 78 x 96 in	10,100
Level 2	140 x 78 x 96 in	10,200
Level 3	200 x 78 x 96 in	11,150

Please allow 6-12 inches for height of exhaust stack.

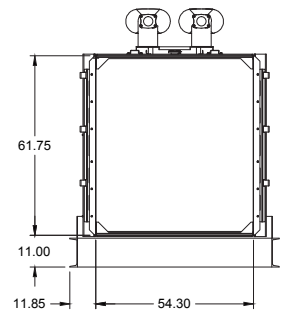
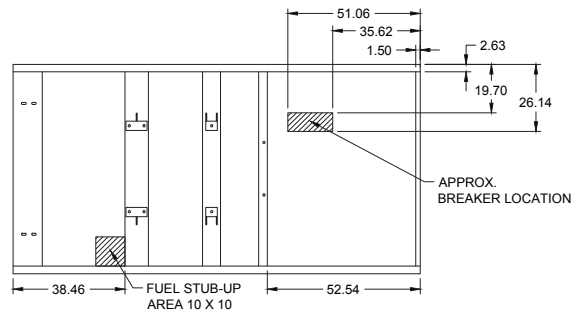

	No Load	Full Load
OPU	82 dBA	85 dBA
Level 1	80 dBA	82 dBA
Level 2	75 dBA	77 dBA
Level 3	70 dBA	72 dBA

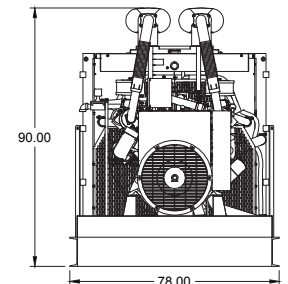
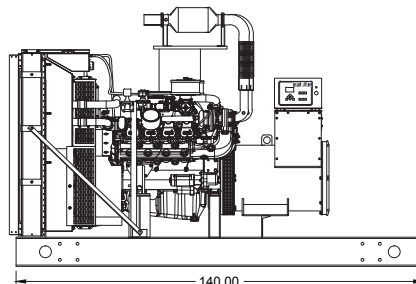

Drawings based on standard open power 480 volt standby generator. Lengths may vary with other voltages. Subject to change without notice. Sound data as measured at 23 feet (7 meters) in accordance with ISO 8528-10 at standby rating.

Gaseous Product Line

265 kWe / 230 kWe



Enclosures

Level 1 & 2 | Side View (Weather Proof)

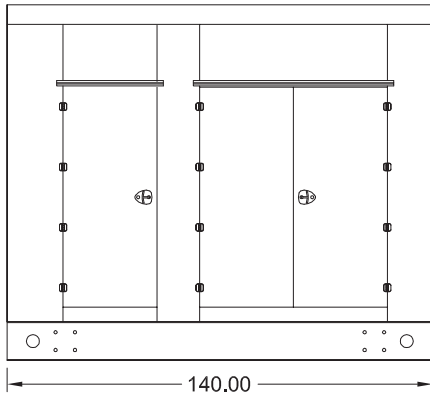

Level 3 | Side View (Sound Attenuated)

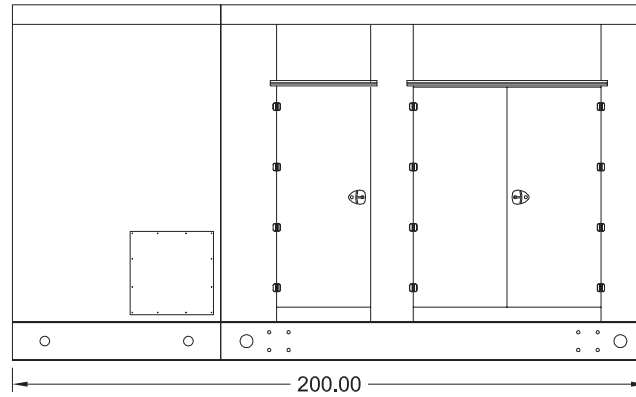

Level 1, 2 & 3 | Intake View

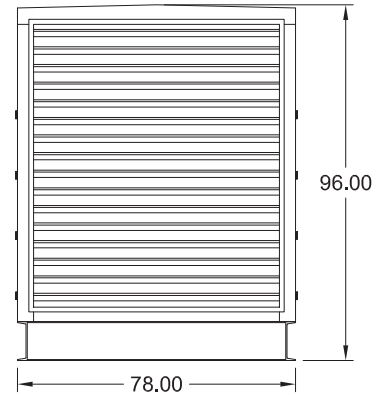

All enclosures are 150 MPH Wind Rated.

Level 2 & 3 enclosures include sound attenuation foam.

Level 3 enclosure includes frontal sound & exhaust hood.

*Enclosure height does not include exhaust stack.

All specification sheet dimensions are represented in inches.
Materials and specifications subject to change without notice.

American Owned



American Made

Distributed By:



Tel: 1-604-746-0606
Web: www.primapowersys.com

Blue Star Power Systems, Inc.

52146 Ember Road
Lake Crystal, Minnesota 56055
Phone + 1 507 726 2508
bluestarps.com
quote.bluestarps.com
sales@bluestarps.com