

BLUE STAR

Power Systems Inc.

Diesel Product Line

208-600 Volt

MD1250-01

60 Hz / 1800 RPM

1250 kWe / 1150 kWe

Standby / Prime

Ratings

	208V	240V	480V	600V
Phase	3	3	3	3
PF	0.8	0.8	0.8	0.8
Hz	60	60	60	60
Generator Model	Consult Factory	Consult Factory	742RSL4048	743RSS4288
Connection	4 LEAD WYE	4 LEAD DELTA	4 LEAD WYE	4 LEAD WYE
Standby				
kWe	1250	1250	1250	1250
AMPS	4342	3763	1881	1505
Temp Rise	Consult Factory	Consult Factory	130°C / 27°C	130°C / 27°C
Prime				
kWe	1150	1150	1150	1150
AMPS	3995	3462	1731	1385
Temp Rise	Consult Factory	Consult Factory	105°C / 40°C	105°C / 40°C

Standard Equipment

Engine

- ▶ Radiator Cooled Unit Mounted (50°C)
- ▶ Blower Fan & Fan Drive
- ▶ Starter & Alternator
- ▶ Oil Pump & Filter
- ▶ Oil Drain Extension w/Valve
- ▶ Governor - Electronic Isochronous
- ▶ 24V Battery System & Cables
- ▶ Air Cleaner (Dry Single Stage)
- ▶ Flexible Fuel Connector
- ▶ EPA Certified Tier 2

Listing Certifications

- ▶ UL 2200 Listed
- ▶ cUL Listed
- ▶ CSA Certified
- ▶ Seismic Certified to IBC 2012

Generator

- ▶ Brushless Single Bearing
- ▶ Automatic Voltage Regulator
- ▶ ± .25% Voltage Regulation
- ▶ 4 Pole, Rotating Field
- ▶ 130°C Standby Temperature Rise
- ▶ 105°C Prime Temperature Rise
- ▶ 100% of Rated Load - One Step
- ▶ 5% Maximum Harmonic Content
- ▶ NEMA MG 1, IEEE and ANSI Standards Compliance for Temperature Rise

Additional

- ▶ Microprocessor Based Digital Control
- ▶ Interface Connection Box
- ▶ Control Panel Mounted in NEMA 12 Enclosure
- ▶ Base - Structural Steel
- ▶ Main Line Circuit Breaker Mounted & Wired
- ▶ Critical Grade Silencer Loose
- ▶ Battery Charger 24V 5 Amp
- ▶ Jacket Water 2 Qty: 9000W 240V w/Isolation Valves
- ▶ Vibration Isolation Mounts (Pad Type)
- ▶ Radiator Duct Flange (OPU Only)
- ▶ Single Source Supplier
- ▶ 2YR / 2000HR Standby Warranty
- ▶ 1YR / 1500HR Prime Warranty
- ▶ Standard Colors - White / Tan / Gray

Application Data

Engine			
Manufacturer:	Mitsubishi	Displacement - Cu. In. (lit):	2,992 (49.0)
Model:	S12R-Y2PTAW-1	Bore - in. (cm) x Stroke - in. (cm):	6.69 (17.0) x 7.09 (18.0)
Type:	4-Cycle	Compression Ratio:	14.5:1
Aspiration:	Turbo Charged, H ₂ O/Air Intercooled	Rated RPM:	1800
Cylinder Arrangement:	12 Cylinder Vee	Max HP Stby (kWm):	1,881 (1,403)

Exhaust System	Standby	Prime
Gas Temp. (Stack): °F (°C)	927 (497)	890 (477)
Gas Volume at Stack Temp: CFM (m ³ /min)	12,570 (356)	11,299 (320)
Maximum Allowable Exhaust Restriction: in. H ₂ O (kPa)	23.6 (5.90)	23.6 (5.90)
Cooling System		
Ambient Capacity of Radiator: °F (°C)	122 (50.0)	122 (50.0)
Maximum Allowable Static Pressure on Rad. Exhaust: in. H ₂ O (kPa)	0.50 (0.12)	0.50 (0.12)
Water Pump Flow Rate: GPM (lit/min)	489 (1,851)	489 (1,851)
Heat Rejection to Coolant: BTUM (kW)	29,045 (508)	26,111 (457)
Heat Rejection to Intercooler: BTUM (kW)	29,045 (508)	26,111 (457)
Heat Radiated to Ambient: BTUM (kW)	8,182 (143)	7,528 (132)
Air Requirements		
Aspirating: CFM (m ³ /min)	4,767 (135)	4,273 (121)
Air Flow Required for Rad.Cooled Unit: CFM (m ³ /min)	69,386 (1,964)	69,386 (1,964)
Air Flow Required for Heat Exchanger/Rem. Rad. CFM (m ³ /min)	Consult Factory For Remote Cooled Applications	
Fuel Consumption		
At 100% of Power Rating: gal/hr (lit/hr)	103 (392)	91.0 (344)
At 75% of Power Rating: gal/hr (lit/hr)	75.1 (284)	68.4 (259)
At 50% of Power Rating: gal/hr (lit/hr)	51.0 (193)	46.4 (176)
Fluids Capacity		
Total Oil System: gal (lit)	39.6 (150)	39.6 (150)
Engine Jacket Water Capacity w/Intercooler: gal (lit)	34.3 (130)	34.3 (130)
System Coolant Capacity: gal (lit)	86.0 (326)	86.0 (326)

Deration Factors

Altitude: Derate 0.5% per 328 ft (100 m) above 3,280 ft (1,000 m) standby and prime. | Temperature: Derate 1.0% per 18°F (10°C) above 104°F (40°C) standby and prime. Consult factory for site conditions above these parameters.

DGC-2020 Control Panel

Standard Features

- ▶ Digital Metering
- ▶ Engine Parameters
- ▶ Generator Protection Functions
- ▶ Engine Protection
- ▶ CAN Bus ECU Communications
- ▶ Windows-Based Software
- ▶ Multilingual Capability
- ▶ Remote Communications to RDP-110 Remote Annunciator
- ▶ 16 Programmable Contact Inputs
- ▶ Up to 15 Contact Outputs (7 standard)
- ▶ UL Recognized, CSA Certified, CE Approved
- ▶ Event Recording
- ▶ IP 54 Front Panel Rating with Integrated Gasket
- ▶ NFPA 110 Compatible

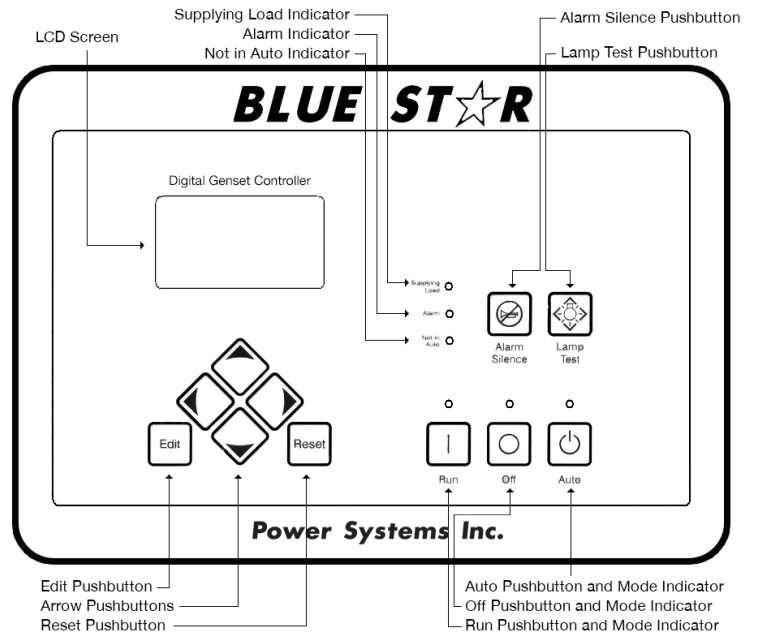

Weights / Dimensions / Sound Data

	L x W x H	Weight lbs
OPU	220 x 95 x 112 in	26,950
Level 1	252 x 106 x 129 in	32,025
Level 2	252 x 106 x 129 in	32,200
Level 3	342 x 106 x 129 in	34,775

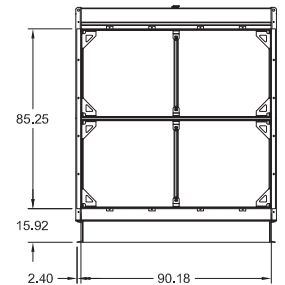
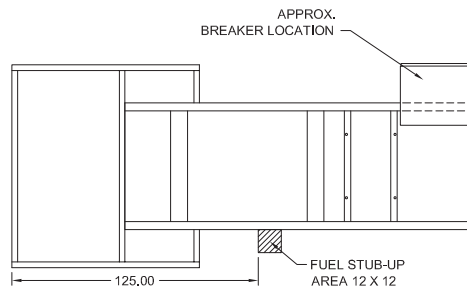

	No Load	Full Load
OPU	89 dBA	91 dBA
Level 1	83 dBA	85 dBA
Level 2	81 dBA	83 dBA
Level 3	77 dBA	79 dBA

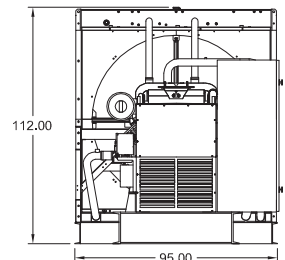
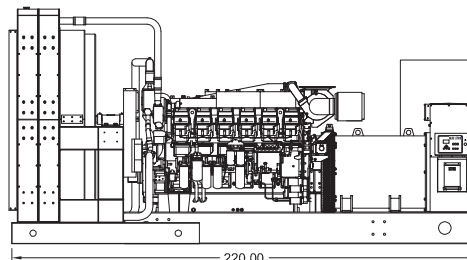

Drawings based on standard open power 480 volt standby generator. Lengths may vary with other voltages. Subject to change without notice. Sound data as measured at 23 feet (7 meters) in accordance with ISO 8528-10 at standby rating.

Diesel Product Line

1250 kWe / 1150 kWe



Enclosures

Level 1 & 2 | Side View (Weather Proof)

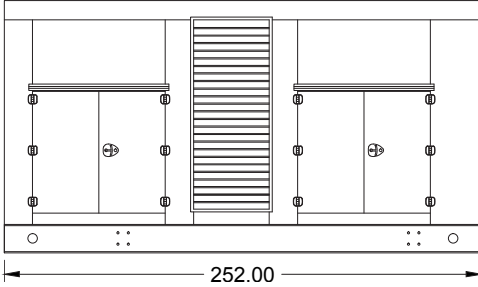

Level 3 | Side View (Sound Attenuated)

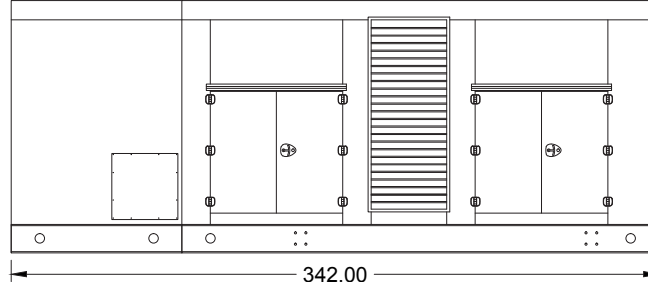

Level 1, 2 & 3 | Intake View

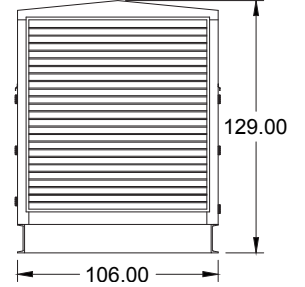

All enclosures are 150 MPH Wind Rated.

Level 2 & 3 enclosures include sound attenuation foam.

Level 3 enclosure includes frontal sound & exhaust hood.

*Enclosure height does not include exhaust system.

Double Wall UL 142 Listed Fuel Tanks

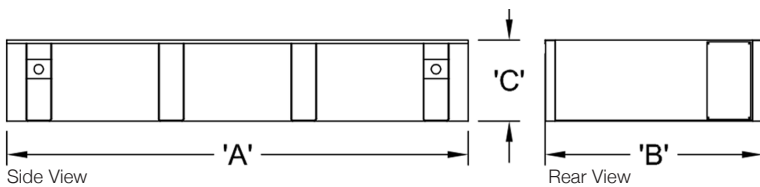
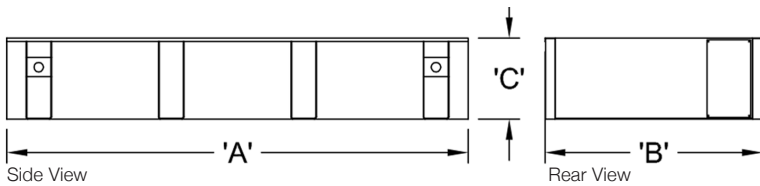

	OPU / Level 1 / Level 2		
	12 Hour 1250 Gallon	24 Hour 2500 Gallon	48 Hour 5000 Gallon
A	252.00	252.00	410.00
B	106.00	106.00	106.00
C	18.00	32.00	36.00

	Level 3		
	12 Hour 1250 Gallon	24 Hour 2500 Gallon	48 Hour 5000 Gallon
A	342.00	342.00	410.00
B	106.00	106.00	106.00
C	12.00	24.00	36.00

All specification sheet dimensions are represented in inches.

All enclosures and fuel tanks are based on the standard standby unit configuration. Any deviation can change dimensions.

Materials and specifications subject to change without notice.

American Owned



American Made

Distributed By:

Tel: 1-604-746-0606
Web: www.primapowersys.com

Blue Star Power Systems, Inc.

52146 Ember Road

Lake Crystal, Minnesota 56055

Phone + 1 507 726 2508

bluestarps.com

quote.bluestarps.com

sales@bluestarps.com